

Datasheet - AZ 15/16-B1

Safety switch with separate actuator / AZ 15 / Actuator



Preferred typ



(Minor differences between the printed image and the original product may exist!)

Ordering details

Product type description	AZ 15/16-B1
Article number	101083036
EAN code	4030661070001
eCl@ss	27-27-92-16

Global Properties

Product name	Gerader Betätiger B1
Weight	15 g

Mechanical data

Design of actuators	straight, rigid
Minimum actuating radius	160 mm

notice

Minimum actuating radius on hinged guards 150 mm

The axis of the hinge should be 5 mm above the top edge of the safety switch and in the same plane

Documents

Operating instructions and Declaration of conformity (es) 115 kB, 12.02.2014

Code: mrl_az15-16-betaetiger_es

Operating instructions and Declaration of conformity (it) 114 kB, 10.02.2014

Code: mrl_az15-16-betaetiger_it

Operating instructions and Declaration of conformity (de) 296 kB, 30.01.2014

Code: mrl_az15-16-betaetiger_de

Operating instructions and Declaration of conformity (nl) 114 kB, 11.03.2014

Code: mrl_az15-16-betaetiger_nl

Operating instructions and Declaration of conformity (pt) 115 kB, 23.05.2014

Code: mrl_az15-16-betaetiger_pt

Operating instructions and Declaration of conformity (jp) 165 kB, 11.08.2014

Code: mrl_az15-16-betaetiger_jp

Operating instructions and Declaration of conformity (en) 114 kB, 24.02.2014

Code: mrl_az15-16-betaetiger_en

Operating instructions and Declaration of conformity (pl) 155 kB, 11.03.2014

Code: mrl_az15-16-betaetiger_pl

Operating instructions and Declaration of conformity (fr) 114 kB, 14.04.2014

Code: mrl_az15-16-betaetiger_fr

Images

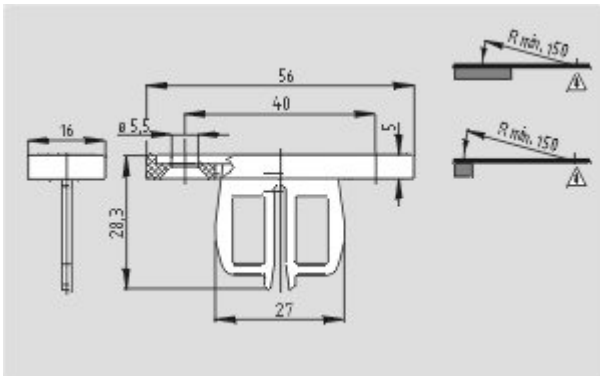

Dimensional drawing (actuator)

K.A. Schmersal GmbH & Co. KG, Möddinghofe 30, D-42279 Wuppertal

The data and values have been checked thoroughly. Technical modifications and errors excepted.

Generiert am 02.02.2015 - 08:01:05h Kasbase 3.1.5.F.64I