

## Datasheet - AZM 161-B1

Solenoid interlock / AZM 161 / Actuator



Preferred typ



(Minor differences between the printed image and the original product may exist!)

### Ordering details

Product type description	AZM 161-B1
Article number	101145117
EAN code	4030661283920
eCl@ss	27-27-92-16

### Global Properties

Product name	Gerader Betätiger AZM 161-B1
Weight	25 g

### Mechanical data

Design of actuators	straight
Minimum actuating radius	150 mm

### notice

The axis of the hinge should be 5 mm above the top edge of the safety switch and in the same plane

On hinged guards, minimum actuating radius at 90° to the plane of the actuator 180 mm

minimum actuating radius on hinged guards in line with the plane of the actuator 150 mm

### Documents

**Mounting and wiring instructions** (de, en, fr, it, es, jp) 203 kB, 08.07.2008

Code: m\_zm1p02

### Images

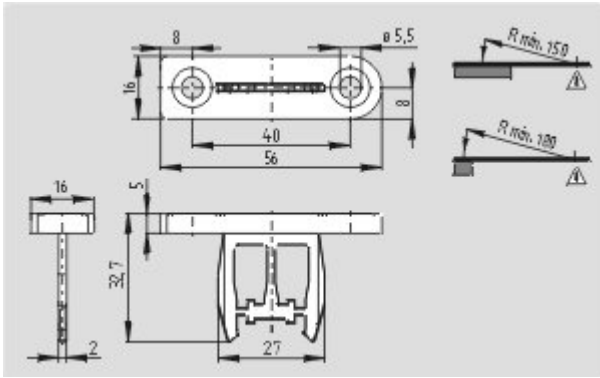

Dimensional drawing (miscellaneous)

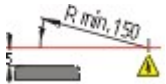

Actuating radius

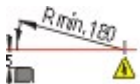

Actuating radius

K.A. Schmersal GmbH & Co. KG, Möddinghofe 30, D-42279 Wuppertal

The data and values have been checked thoroughly. Technical modifications and errors excepted.

Generiert am 02.02.2015 - 08:02:28h Kasbase 3.1.5.F.64I