

Datasheet - AZM 161-B6

Solenoid interlock / AZM 161 / Actuator

 Preferred typ

• For very small actuating radii

(Minor differences between the printed image and the original product may exist!)

Ordering details

Product type description	AZM 161-B6
Article number	101144420
EAN code	4030661283210
eCl@ss	27-27-92-16

Global Properties

Product name	Beweglicher Betätiger AZM 161-B6
Weight	35 g

Mechanical data

Design of actuators	flexible
Minimum actuating radius	95 mm

notice

The axis of the hinge should be 11 mm above the top edge of the safety switch and in the same plane

Similarly, minimum actuating radius 95 mm in line with the plane of the actuator, adjustable using an hexagonal key wrench 2,5 mm A/F (a)

On hinged guards, minimum actuating radius 95 mm, at 90° to the plane of the actuator, adjustable using an hexagonal key wrench 2,5 mm A/F (b)

Documents

Mounting and wiring instructions (de, en, fr, it, es, jp) 203 kB, 08.07.2008

Code: m_zm1p02

Images

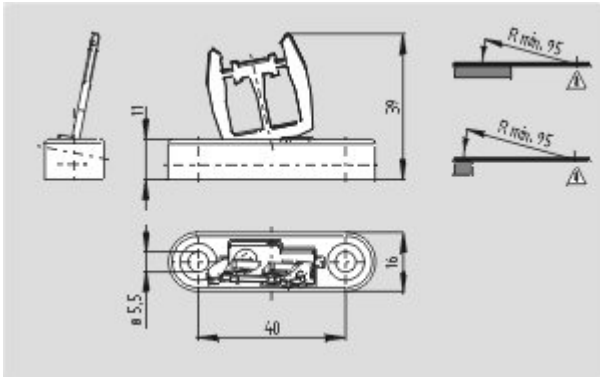

Dimensional drawing (miscellaneous)

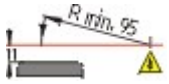

Actuating radius

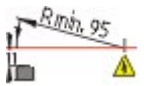

Actuating radius

K.A. Schmersal GmbH & Co. KG, Möddinghofe 30, D-42279 Wuppertal

The data and values have been checked thoroughly. Technical modifications and errors excepted.

Generiert am 02.02.2015 - 08:03:21h Kasbase 3.1.5.F.64I